

COMBI

Compact drawer

Injected drawer up to 600 mm. Three lengths for greater capacity. Now with the option of incorporating INDAmatic, the soft close system by Indaux.



INDAmatic

1 COMBI-275 DRAWER

Drawer

COMBI-275 Drawer.

Module	White RAL 9001	
175	680.417.006	25
200	680.420.005	
250	680.425.001	
300	680.430.004	
350	680.435.000	
400	680.440.003	



Runner

Runner.

Lenght	Extension loss PS	White RAL 9001	
275	50	788.116.000	100



Each reference consists of 1 set.

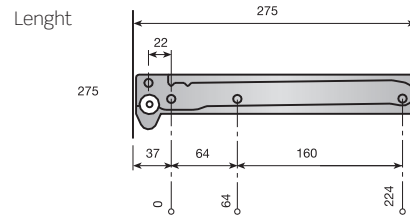
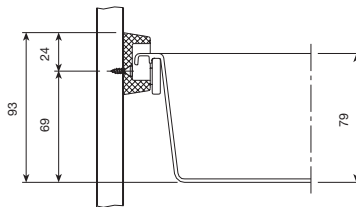

Front fixing brackets

Adjustable front fixing brackets.

White RAL 9001	
685.000.002	100

Reference consists of a complete set of fixing brackets.

Adjustable front fixing brackets, 15 mm with wings.

White RAL 9001	
685.200.003	100

Reference consists of a complete set of fixing brackets.

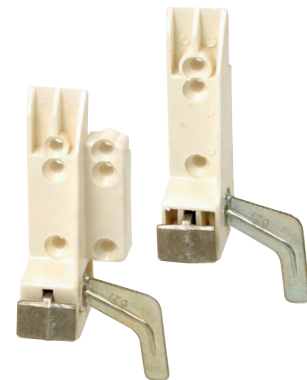
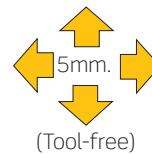

Module	F
175	37
200	62
250	112
300	162
350	212
400	262

NOTE
To fit front coupler with wings, 30 mm. Must be added to figure F.

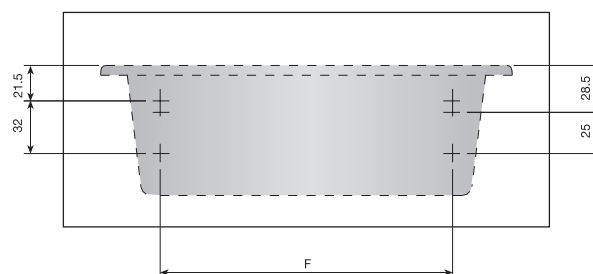

2 COMBI-440 DRAWER

Drawer

COMBI-440 Drawer.

Module	White RAL 9001	Beige RAL 1015	
300	680.330.000	680.330.464	
350	680.335.003	680.335.460	
400	680.340.006	680.340.463	25
450	680.345.002	680.345.466	
500	680.350.005	680.350.462	
600	680.360.004	680.360.461	



COMBI-440 KIT-4 Drawer.

Module	White RAL 9001	
300	681.430.002	
350	681.435.005	
400	681.440.001	1
450	681.445.004	
500	681.450.000	
600	681.460.006	

Each box contains 4 drawers with their corresponding runners, front fixing brackets and screws.

COMBI-440 KIT-5 Drawer.

Module	White RAL 9001	
300	681.530.006	
350	681.535.002	
400	681.540.005	1
450	681.545.001	
500	681.550.004	
600	681.560.003	

Each box contains 5 drawers with their corresponding runners, front fixing brackets and screws.

Module	Width	Length	Height
300	250		
350	300		
400	350	435	79
450	400		
500	450		
600	550		

Runners

Runners for 15÷16 mm end panel.

Ext. loss	White RAL 9001	Beige RAL 1015	
90	789.216.002	789.216.466	100

Each reference consists of 1 set.



Runners for 18÷19 mm end panel.

Ext. loss	White RAL 9001	
90	789.219.001	100

Each reference consists of 1 set.

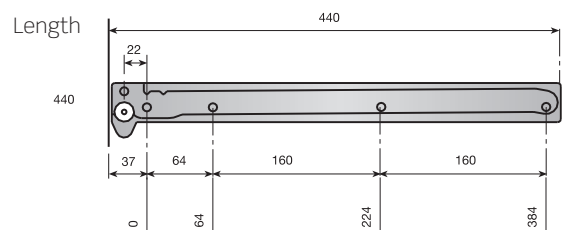
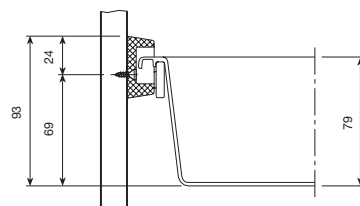

■ Drawer front fixing brackets

Adjustable front fixing bracket.

White RAL 9001	Beige RAL 1015	
685.000.002	685.000.466	100

Reference consists of a complete set of fixing brackets.

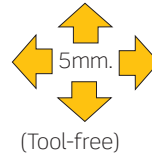

Adjustable front fixing bracket, 15 mm with wings.

White RAL 9001	Beige RAL 1015	
685.200.003	685.200.460	100

Reference consists of a complete set of fixing brackets.

Module	F
300	162
350	212
400	262
450	312
500	362
600	462

NOTE
To fit front fixing bracket with wings "B", 30 mm. must be added to figure F.

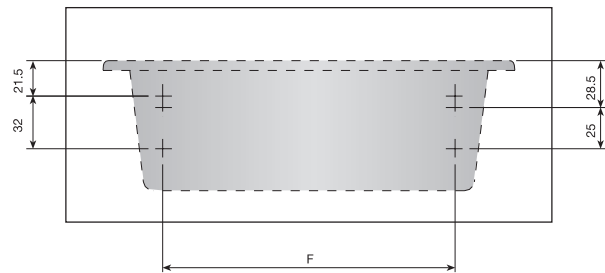

■ Pan drawer accessories

COMBI-440 Pan drawer frame.

Module	L	Chrome	
300	230	745.230.124	20
350	280	745.235.120	
400	330	745.240.123	
450	380	745.245.126	
500	430	745.250.122	
600	530	745.260.121	

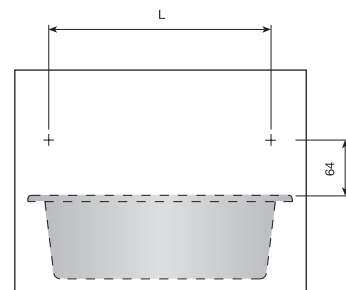
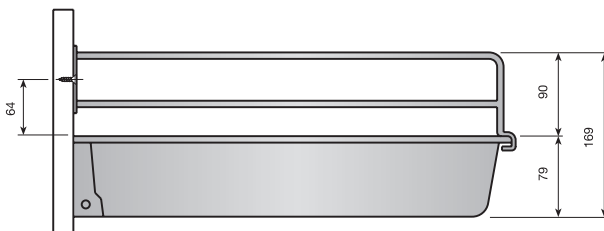

Cutlery Tray

Cutlery trays designed for COMBI drawer widths. This cutlery tray comes in two versions: fitted on all four sides, for all modules, and with a lateral flap for drawers from modules 350 and 450 upwards, offering greater versatility as they may be used with a range of models.

COMBI-440 Cutlery tray.

Module	White RAL 9001	Beige RAL 1015	Measurements			
			Length	Width		Height
300	687.130.006	687.130.463	391	206	45	25
350	689.035.001	689.035.465	391	256	45	20
400	687.140.005	687.140.462	391	306	45	25
450	689.045.000	689.045.464	391	356	45	20
500	689.050.003	689.050.460	391	406	45	20
600	689.060.002	689.060.466	391	506	45	20

Without flap. Adjustable to any drawer module.



COMBI-440 Cutlery tray, with flap.

Module	White RAL 9001	Beige RAL 1015	
450	687.145.001	687.145.465	

Cutlery trays with flap for drawer modules from 350 and 450 respectively.



3 COMBI-480 DRAWER

Drawer

COMBI-480 Drawer.

Module	White RAL 9001	Metallic grey	
300	681.030.000	681.030.313	
350	681.035.003	681.035.316	
400	681.040.006	681.040.312	25
450	681.045.002	681.045.315	
500	681.050.005	681.050.311	
600	681.060.004	681.060.310	

In boxes of 25 units.



COMBI-480 KIT-4 Drawer.

Module	White RAL 9001	Gris Metalizado	
300	681.130.004	681.130.310	
350	681.135.000	681.135.313	
400	681.140.003	681.140.316	1
450	681.145.006	681.145.312	
500	681.150.002	681.150.315	
600	681.160.001	681.160.314	

Each box contains 4 drawers with their corresponding runners, front fixing brackets and screws.



COMBI-480 KIT-5 Drawer.

Module	White RAL 9001	Metallic grey	
300	681.230.001	681.230.314	
350	681.235.004	681.235.310	
400	681.240.000	681.240.313	1
450	681.245.003	681.245.316	
500	681.250.006	681.250.312	
600	681.260.005	681.260.311	

Each box contains 5 drawers with their corresponding runners, front fixing brackets and screws.

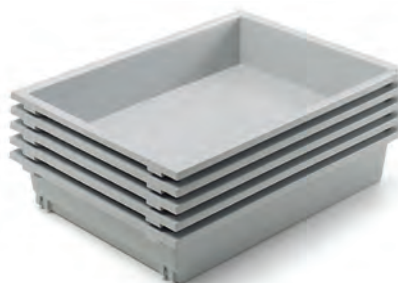

Runners

Runner for 15÷16mm. end panel.

Ps	White RAL 9001	Metallic grey	
90	788.316.001	788.316.314	100

Each reference consists of 1 set.

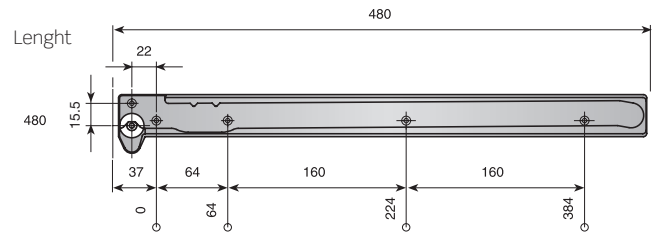
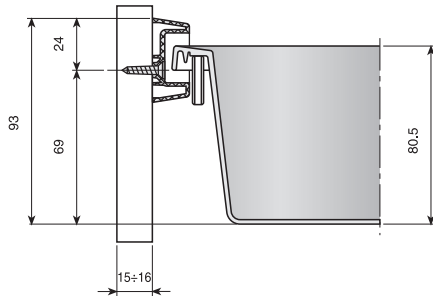

Front fixing brackets

Adjustable front fixing brackets.

	White RAL 9001	Metallic grey	
	685.000.002	685.000.315	100

Reference consists of a complete set of fixing brackets.

Adjustable front fixing brackets, 15mm with wings.

	White RAL 9001	Metallic grey	
	685.200.003	685.200.316	100

Reference consists of a complete set of brackets.

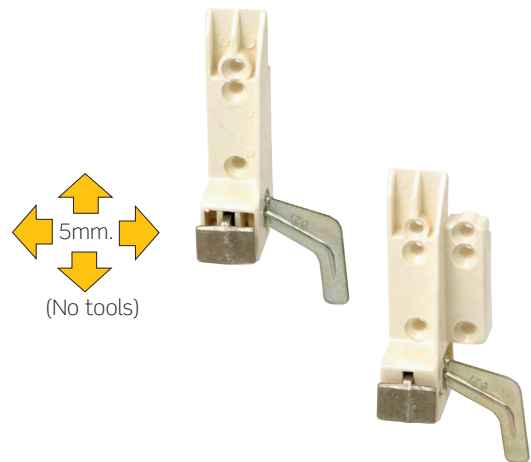

Module	F
300	162
350	212
400	262
450	312
500	362
600	462

NOTE
To fit front fixing bracket with wings "C", 30mm. must be added to figure F.

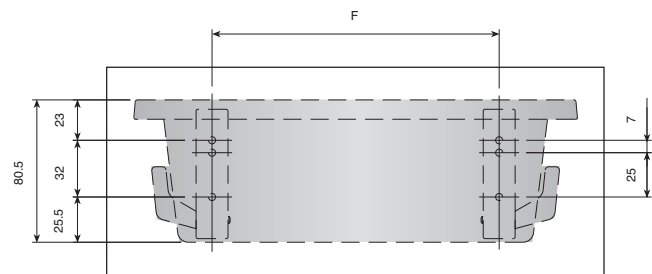

■ Pan drawer accessories

COMBI-480 Pan drawer frame.

Module	L	Chrome	
300	230	745.330.121	20
350	280	745.335.124	
400	330	745.340.120	
450	380	745.345.123	
500	430	745.350.126	
600	530	745.360.125	

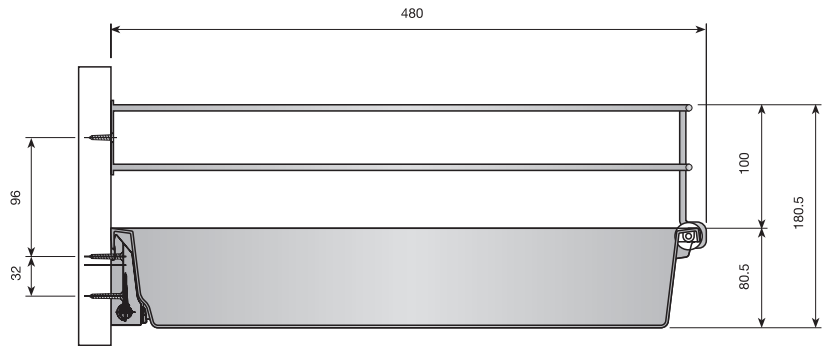
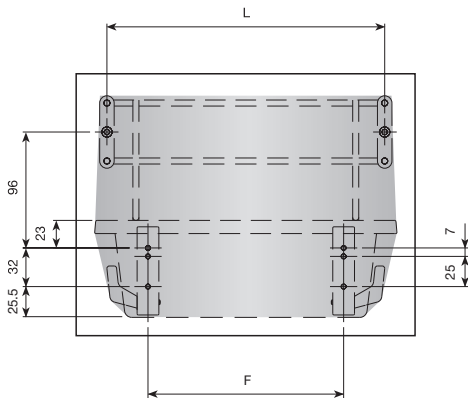
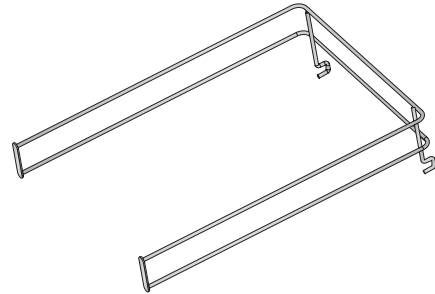

■ Cutlery Trays

Specially designed for COMBI drawer. Available in two versions: Adjusted to every module from 300 to 600 and with lateral flap, adaptable to modules from 350 and from 450. Injection moulded with a very resistant impactproof material, obtaining very uniform and strong walls.

COMBI-480 Cutlery tray.

Module	White RAL 9001	Metallic grey	
300*	687.930.003	687.930.316	20
350	687.635.001	687.635.314	
400*	687.940.002	687.940.315	
450	687.645.000	687.645.313	
500	687.650.003	687.650.316	
600	687.660.002	687.660.315	

* In boxes of 25 units.

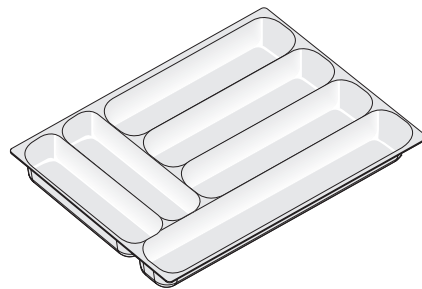

COMBI-480 Cutlery tray, with flap.

Module	White RAL 9001	Metallic grey	
350	687.935.006	687.935.312	25
450	687.945.005	687.945.311	

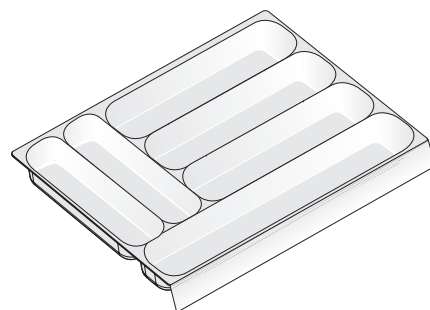

■ Accessories: non-slip mat

Non-slip mat for all drawers, particularly pan drawers, to prevent utensils from slipping and scratching the base. It may be cut directly from the roll according to the drawer's measurements.

Non-slip mat.

Grey	443.050.300	1
------	-------------	---



Supplied in rolls of 20m. Long x 500mm. Wide.

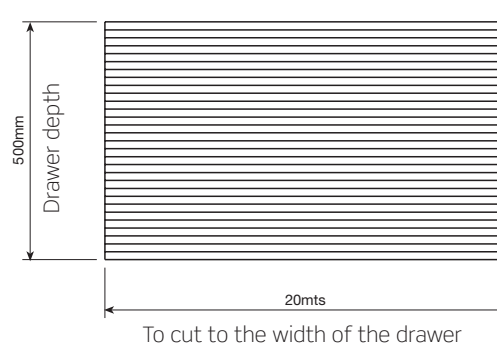

■ COMBI-480 INDAmatic

INDAmatic

INDAmatic set for COMBI-480 drawer

				
White	RAL 9001	198.900.004		50
Grey	RAL 7040	198.900.310		

Each reference consists of one soft-close device and one fixing bracket.

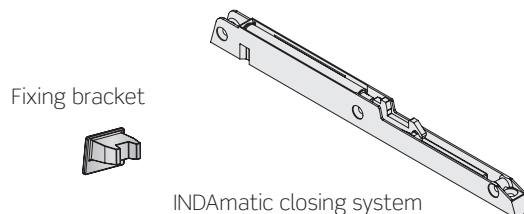

COMBI-480 Drawer with INDAMATIC cavity.

Module	White RAL 9001	Metallic grey		
300	683.230.004	683.230.310		25
350	683.235.000	683.235.313		
400	683.240.003	683.240.316		
450	683.245.006	683.245.312		
500	683.250.002	683.250.315		
600	683.260.001	683.260.314		

In boxes of 25 units.



COMBI-480 KIT-4 Drawer with INDAMATIC cavity.

Module	White RAL 9001	Gris Metalizado		
300	686.330.002	686.330.315		1
350	686.335.005	686.335.311		
400	686.340.001	686.340.314		
450	686.345.004	686.345.310		
500	686.350.000	686.350.313		
600	686.360.006	686.360.312		

Each box contains 4 drawers with their corresponding runners, front fixing brackets and screws.



COMBI-480 KIT-5 Drawer with INDAMATIC cavity.

Module	White RAL 9001	Metallic grey		
300	686.430.006	686.430.312		1
350	686.435.002	686.435.315		
400	686.440.005	686.440.311		
450	686.445.001	686.445.314		
500	686.450.004	686.450.310		
600	686.460.003	686.460.316		

Each box contains 5 drawers with their corresponding runners, front fixing brackets and screws.

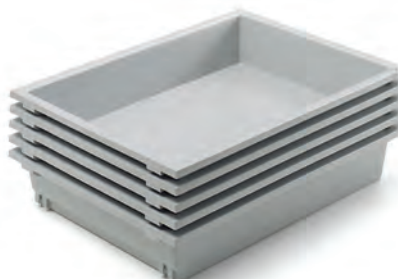

> Runners

Runner for 15÷16mm. end panel.

Ps	White RAL 9001	Metallic grey	
90	788.316.001	788.316.314	100

Each reference consists of 1 set.

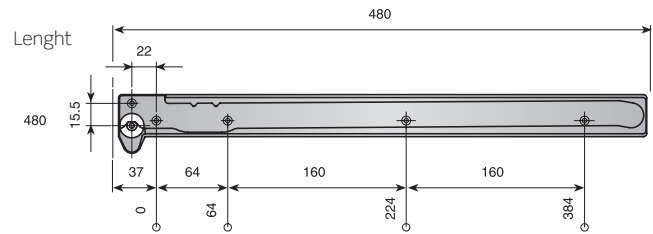
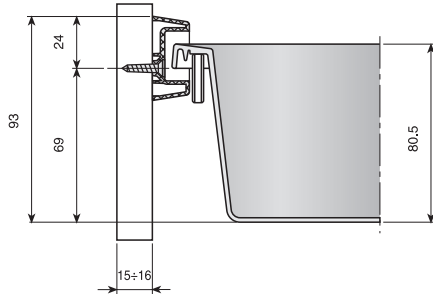

> Front fixing brackets

Adjustable front fixing brackets.

	White RAL 9001	Metallic grey	
	685.000.002	685.000.315	100

Reference consists of a complete set of fixing brackets.

Adjustable front fixing brackets, 15mm with wings.

	White RAL 9001	Metallic grey	
	685.200.003	685.200.316	100

Reference consists of a complete set of brackets.

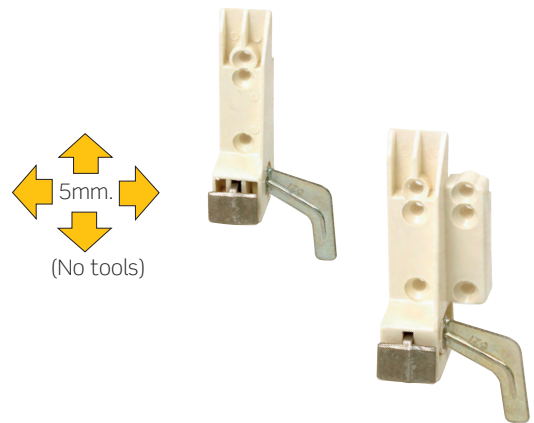

Module	F
300	162
350	212
400	262
450	312
500	362
600	462

NOTE
To fit front fixing bracket with wings "C", 30mm. must be added to figure F.

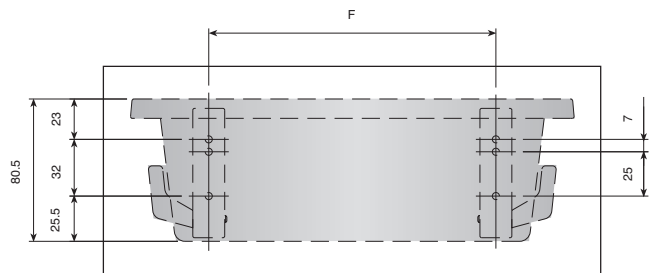

Assembly

Fixing method to the side panel

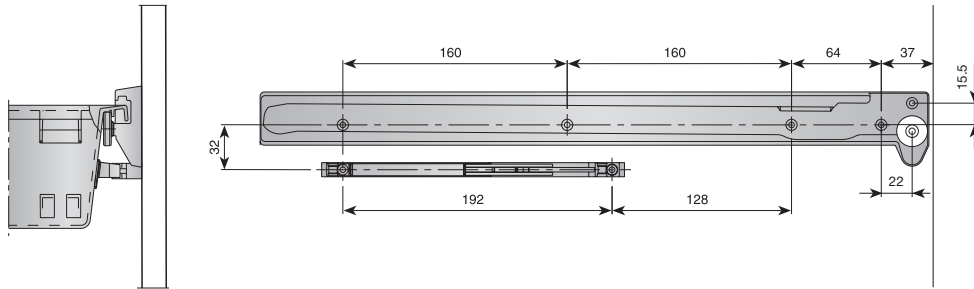

Fixing bracket assembly

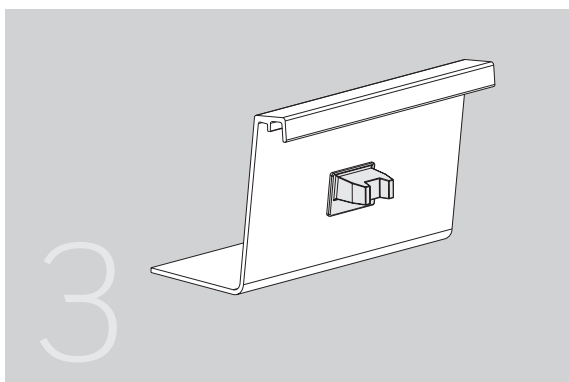
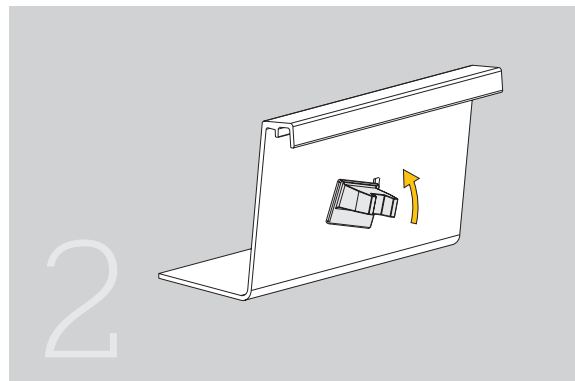
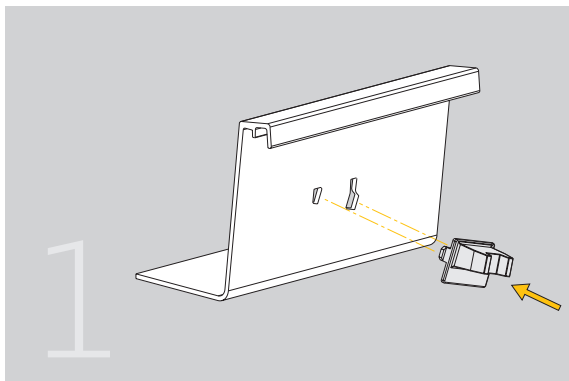

NOTE
The INDAmatic gradual soft closing system is installed on the right side of the drawer.

