

GACELA

Roller runners



1 GACELA

GACELA runner

Self-closing GACELA runner.

Length	White RAL 9001	Black RAL 9005	Ext. Loss	
250	760.025.803	760.025.825	59	100
300	760.030.806	760.030.821	68	
350	760.035.802	760.035.824	77	
400	760.040.805	760.040.820	86	
450	760.045.801	760.045.823	95	
500	760.050.804	760.050.826	104	
550	760.055.800	760.055.822	113	
600	760.060.803	760.060.825	122	
700*	760.070.802	760.070.824	140	
800*	760.080.801	760.080.823	158	

In these references, the 4 profiles are packed separately in boxes of 100 units. 700 and 800 lengths come in 4 boxes of 50 units.



GACELA runner: sets.

Length	White RAL 9001	Black RAL 9005	Ext. Loss	
250	760.125.800	760.125.822	59	30
300	760.130.803	760.130.825	68	
350	760.135.806	760.135.821	77	
400	760.140.802	760.140.824	86	
450	760.145.805	760.145.820	95	
500	760.150.801	760.150.823	104	

In these references, the 4 profiles are packed together in boxes of 30 sets. Minimum order: 300 sets.

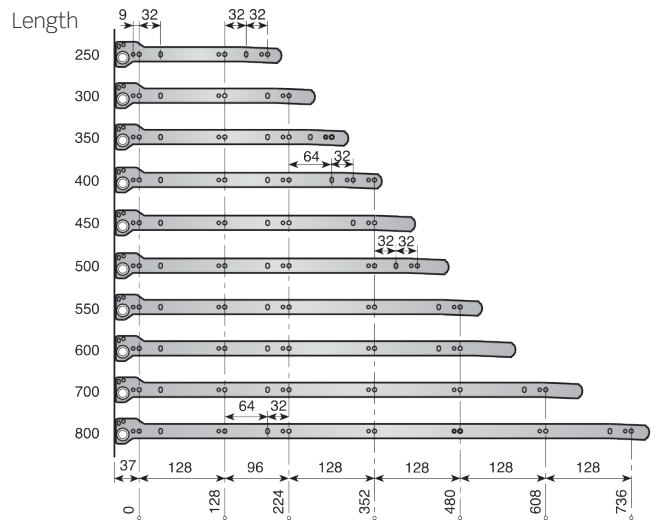

Euro-screw.

	Ø7	Ø7.75	
Nickel-plated	952.810.062	953.610.066	5.000

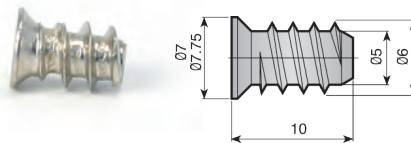

Assembly

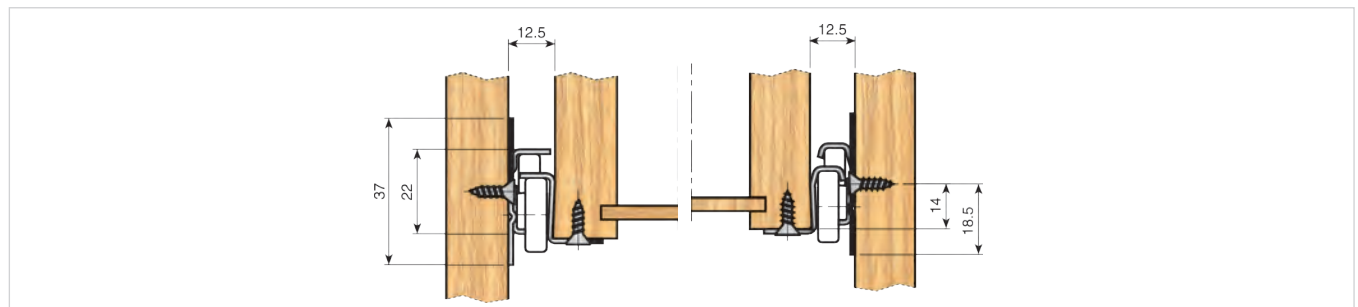

GACELA adjustable runner

GACELA runner, pin fixing

Length	White RAL 9001	Black RAL 9005	Ext. Loss PS	Extension DC	
250	759.525.804	759.525.826	59	128	100
300	759.530.800	759.530.822	68	160	
350	759.535.803	759.535.825	77	224	
400	759.540.806	759.540.821	86	256	
450	759.545.802	759.545.824	95	288	
500	759.550.805	759.550.820	104	320	

In these references, the 4 profiles are packed separately in boxes of 100 units. A 10mm key is available for adjustments. Ref.: 700.500.102.



GACELA runner, screw-on fixing

Length	White RAL 9001	Black RAL 9005	Ext. Loss PS	Extension DC	
250	759.025.805	759.025.820	59	128	100
300	759.030.801	759.030.823	68	160	
350	759.035.804	759.035.826	77	224	
400	759.040.800	759.040.822	86	256	
450	759.045.803	759.045.825	95	288	
500	759.050.806	759.050.821	104	320	

In these references, the 4 profiles are packed separately in boxes of 100 units. A 10mm key is available for adjustments ref. 700.500.102.



Assembly

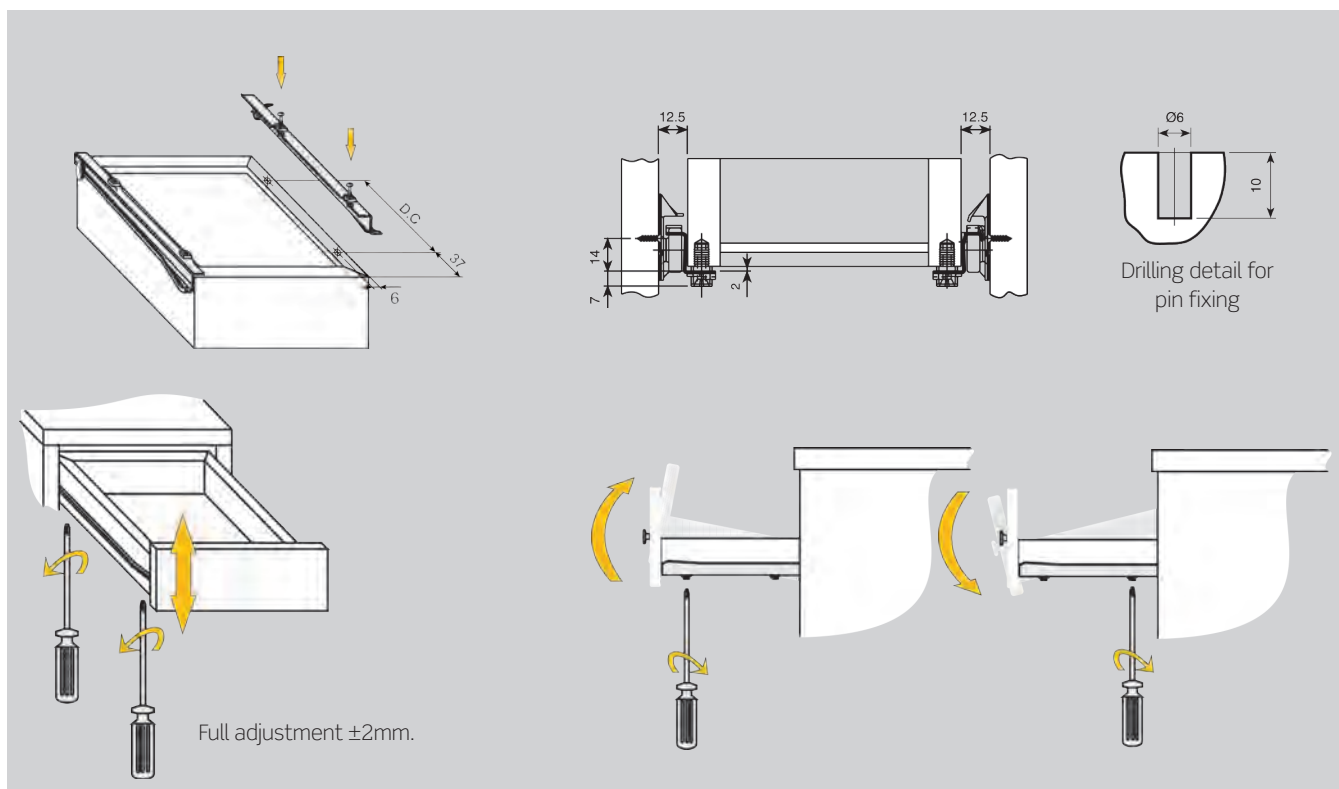

■ GACELA runner for dowel-fix drawer assembly

GACELA runner for dowel-fix drawer assembly.

Length	White RAL 9001	Black RAL 9005	Ext. Loss	
250	760.725.803	760.725.825	59	100
300	760.730.806	760.730.821	68	
350	760.735.802	760.735.824	77	
400	760.740.805	760.740.820	86	
450	760.745.801	760.745.823	95	
500	760.750.804	760.750.826	104	

In these references, the 4 profiles are packed separately in boxes of 100 units.

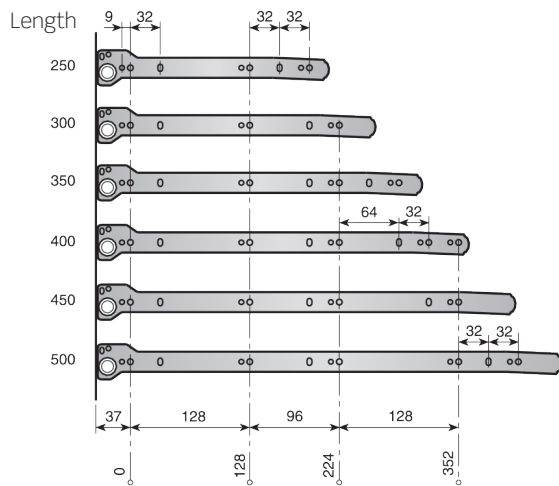

GACELA crimping tool.

	751.600.102	1
---	-------------	---

This is a simple pneumatic tool which fixes the runner to the drawer between two clamps. The tool comes automatically with spring loaded hanging device for easy access.

Assembly: turn the drawer upside down and place the runner on the drawer side. Place the clamps of the tool over each set of clips and press the button.



Assembly

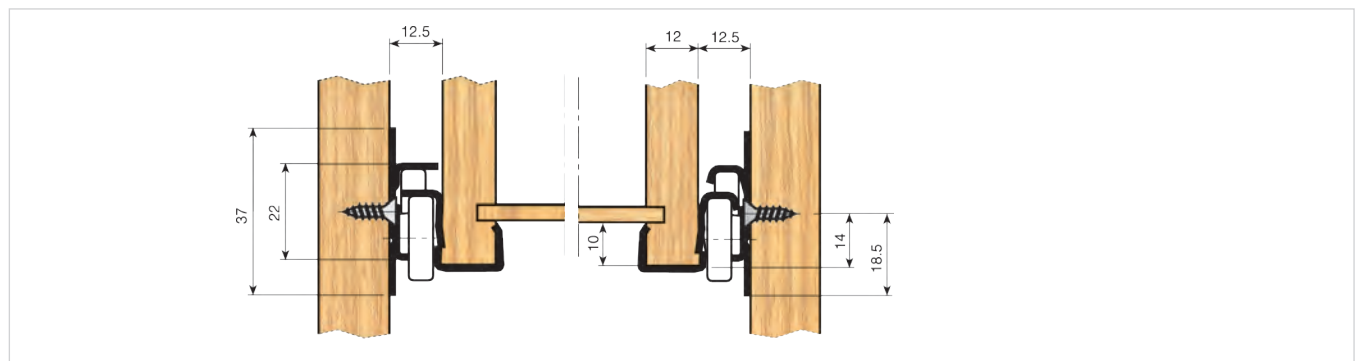

■ GACELA quick assembly runners

GACELA quick assembly runner.

Length	Drawer	White RAL 9001	C	Loss of extension PS	
350	330	760.235.803	303	77	100
400	380	760.240.806	353	86	
450	430	760.245.802	403	95	
500	480	760.250.805	453	104	

In these references, the 4 profiles are packed separately in boxes of 100 units.

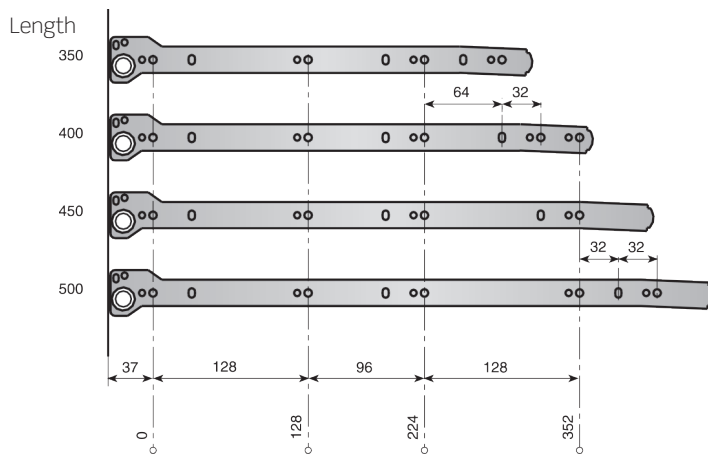

Assembly

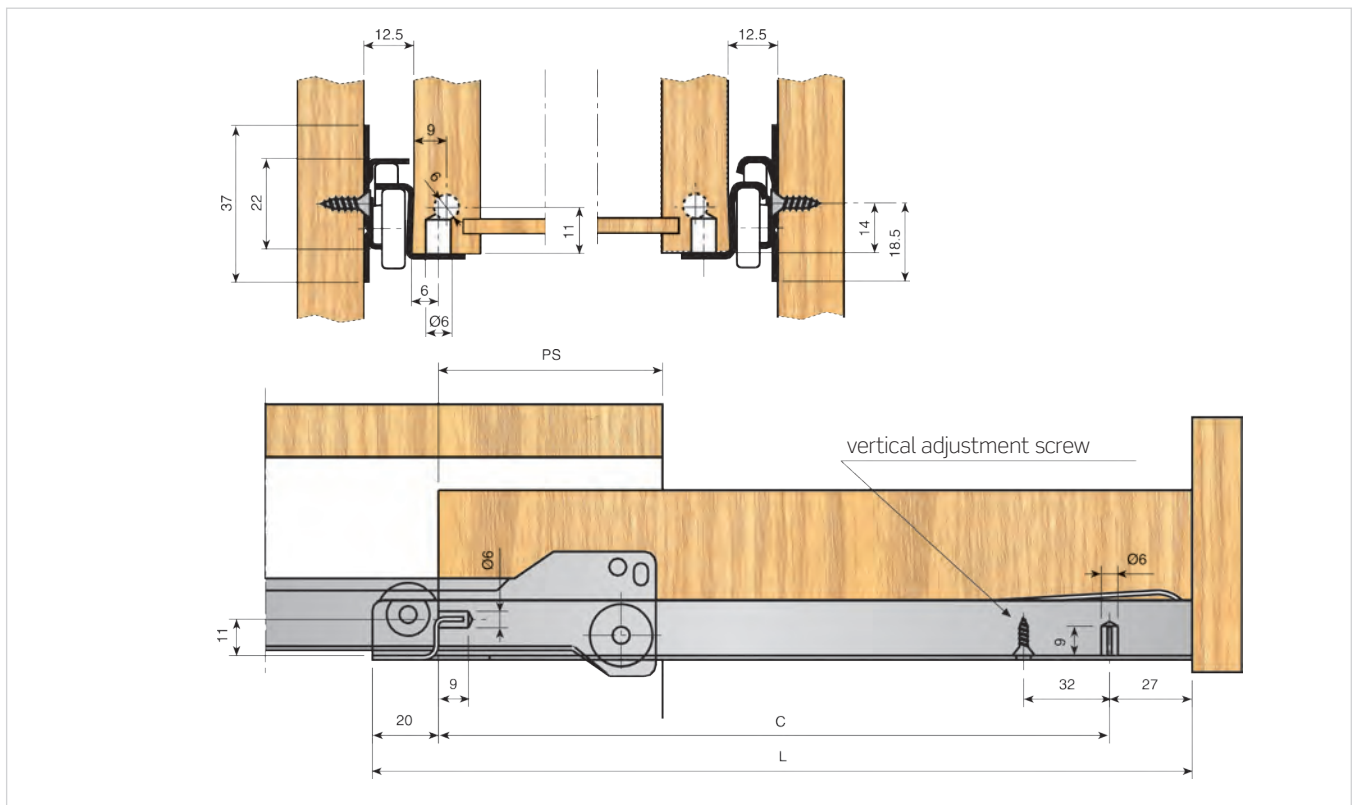

2 GACELA-X

The GACELA-X can be used with the INDAmatic system independently, to offer extra comfort.

GACELA-X runner: screw-fix assembly.

Length	White RAL 9001	Black RAL 9005	Grey	
300	758.930.001	758.930.023	758.930.314	25
350	758.935.004	758.935.026	758.935.310	
400	758.940.000	758.940.022	758.940.313	
450	758.945.003	758.945.025	758.945.316	
500	758.950.006	758.950.021	758.950.312	
550	758.955.002	758.955.024	758.955.315	
600	758.960.005	758.960.020	758.960.311	

Each reference consists of 1 set.



GACELA-X runner: clamp-on assembly.

Length	White RAL 9001	Black RAL 9005	Grey	
300	758.830.004	758.830.026	758.830.310	100
350	758.835.000	758.835.022	758.835.313	
400	758.840.003	758.840.025	758.840.316	
450	758.845.006	758.845.021	758.845.312	
500	758.850.002	758.850.024	758.850.315	
550	758.855.005	758.855.020	758.855.311	
600	758.860.001	758.860.023	758.860.314	

In these references, the 4 profiles are packed separately in boxes of 25 units.

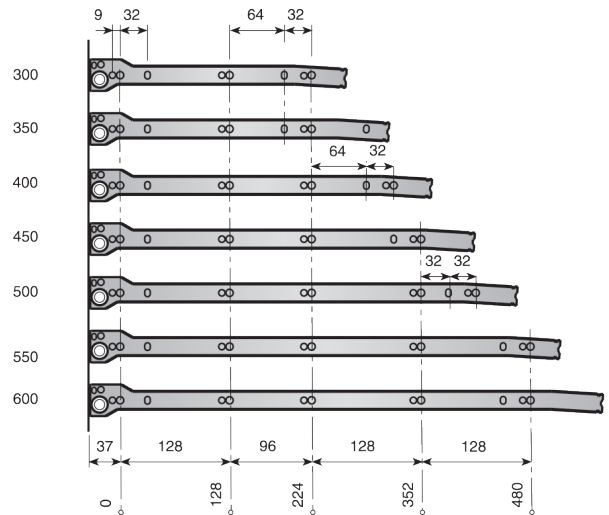

Set of GACELA-X runner: screw-fix assembly.

Length	White RAL 9001	Grey	
300	755.730.006	755.730.312	25
350	755.735.002	755.735.315	
400	755.740.005	755.740.311	
450	755.745.001	755.745.314	
500	755.750.004	755.750.310	
550	755.755.000	755.755.313	
600	755.760.003	755.760.316	

Each reference consists of 1 set.

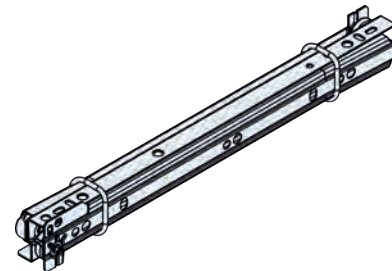

Assembly

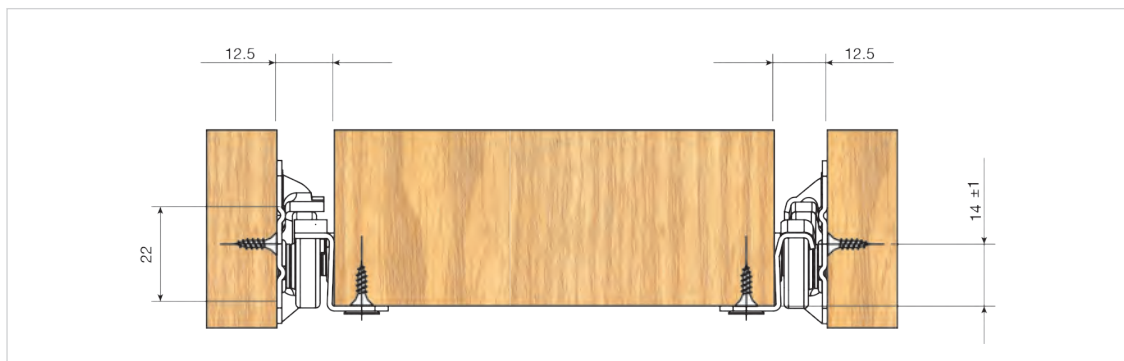

3 INDAmatic SETS FOR GACELA

■ UNIVERSAL INDAmatic SET FOR GACELA

INDAmatic system + fixing bracket set for GACELA and GACELA-X.

Grey	197.980.101	50
------	-------------	----

Each reference consists of one soft-close device and one fixing bracket.

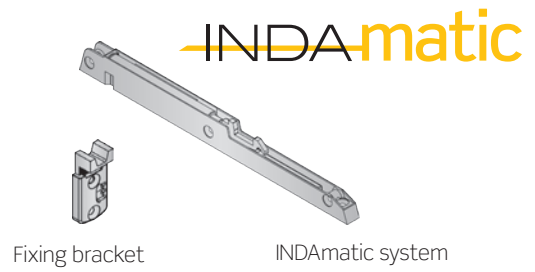

Assembly

Fixing method to the side

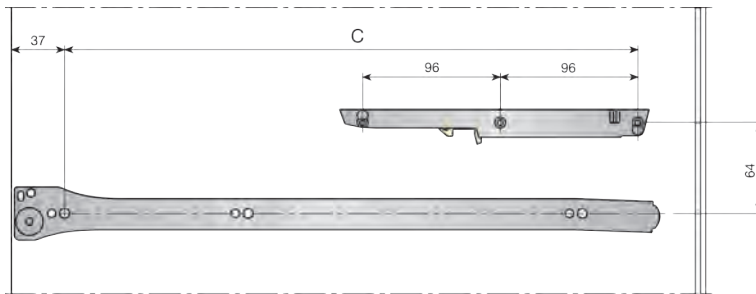

Length	B	C
250	108	192
300	140	224
350	204	288
400	268	352
450	300	384
500	364	448
550	396	480
600	460	544
700	556	640
800	652	736

Fixing method to the drawer

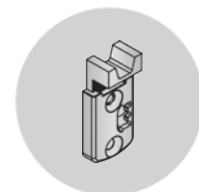
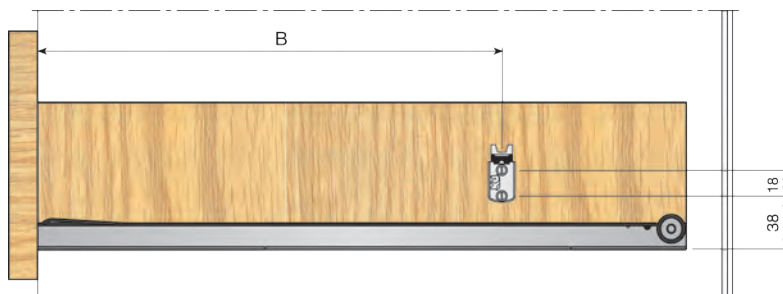

Fixing bracket adjustment

① Release

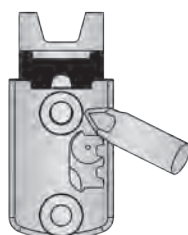

② Vertical adjustment

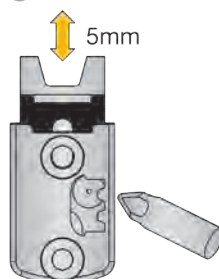

③ Fix

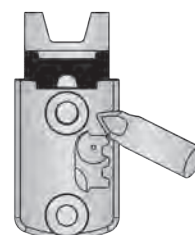

■ **UNIVERSAL INDAmatic SET, QUICK ASSEMBLY**

Indaux has developed a new universal INDAmatic system for wood drawers which can be used with any GACELA type runner. In this system the INDAmatic device is placed in a more advanced position, making the assembly faster and easier, without the need to previously measure and mark.

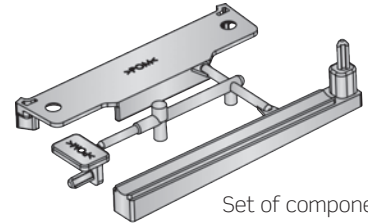
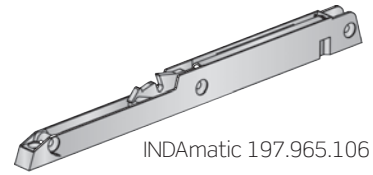

INDAmatic set for GACELA.

RAL 7043	722.820.140	20
----------	-------------	----

Each reference consists of 20 soft-closing devices, 20 sets of components and assembly instructions.

Assembly

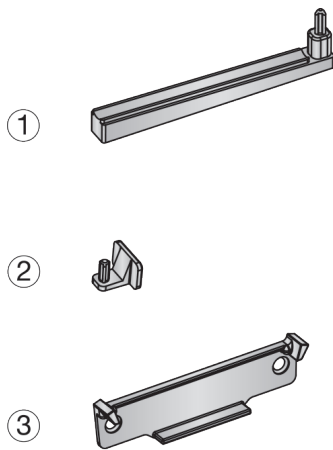

INDAmatic

Once separated, components become:

- 1 - INDAmatic body support guide
- 2 - Longitudinal positioning guide
- 3 - Fixing bracket



